

ADUROS
ERIA

User Manual
4" Smart Recessed Downlight
Dimmable, Tunable White

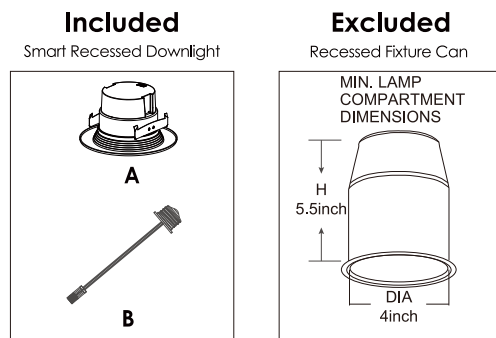

INSIDE THE BOX
SUITABLE FOR TYPE IC OR NON-IC LUMINAIRES.



Part	Description
A	Smart Recessed Downlight
B	Edison socket adapter
C	Luminaire Marking Label (Service Label)
D	Manual

Model	Input Voltage	Wattage	Lumen
89843	110-130V.50/60Hz	10W	850

INSTALLATION INSTRUCTIONS

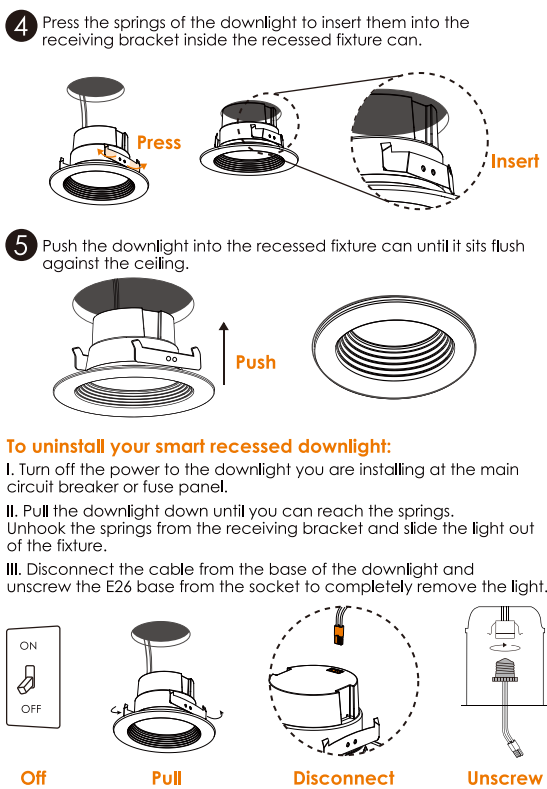
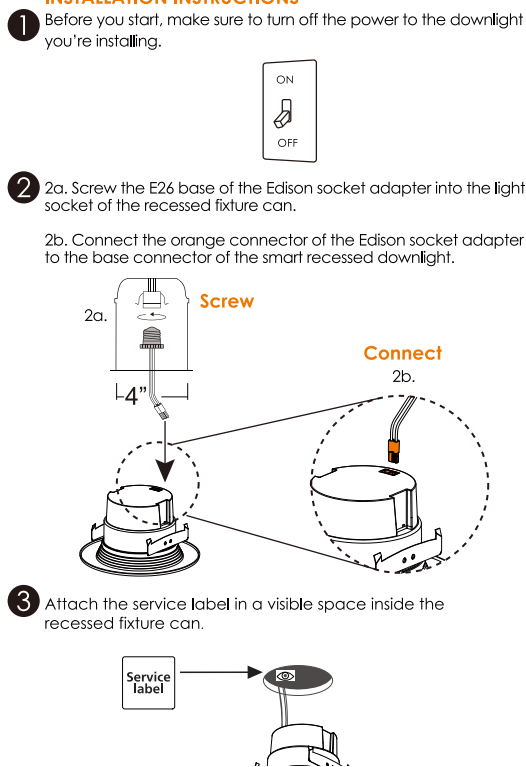

Introduction

The ERIA Dimmable, Tunable White Smart Recessed Downlights offer easy plug-and-play wireless control for smart lighting. Simply pair with an ERIA hub or any compatible Zigbee hub or bridge.

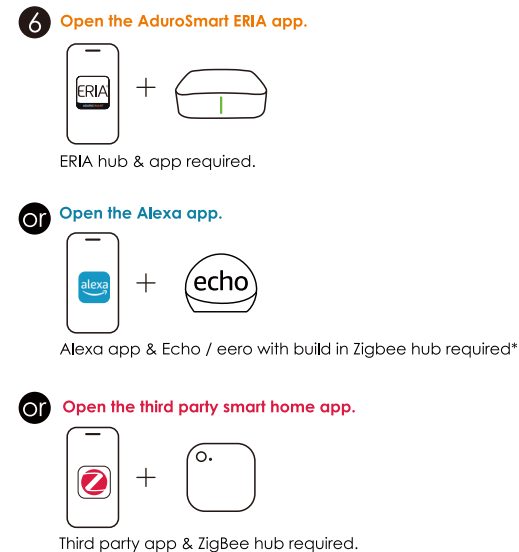

*Connect this bulb directly to Echo and eero devices with built-in Zigbee hubs, including Echo Hub, Echo 4th Gen, Echo Plus, Echo Show 10 (2nd Gen and newer), Echo Studio, eero 6 & 6+, eero Pro 6 & Pro 6E, eero PoE 6 & PoE Gateway, and eero Max 7. (For other models, a separate Zigbee bridge or hub is needed).

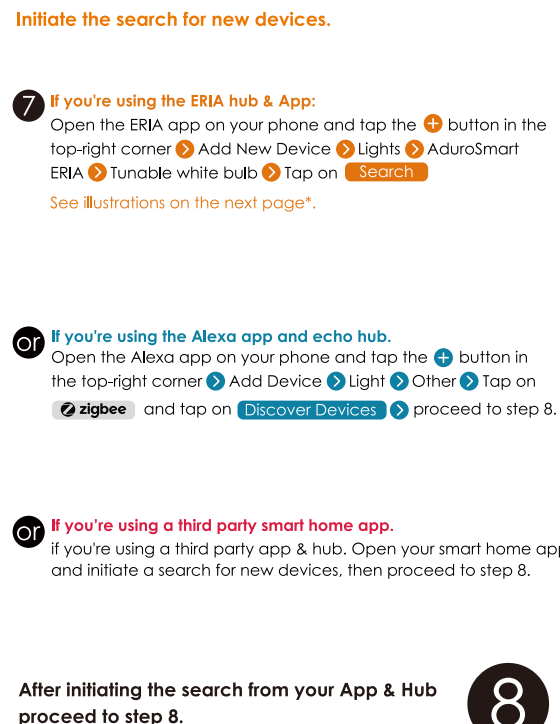

After initiating the search from your App & Hub proceed to step 8.

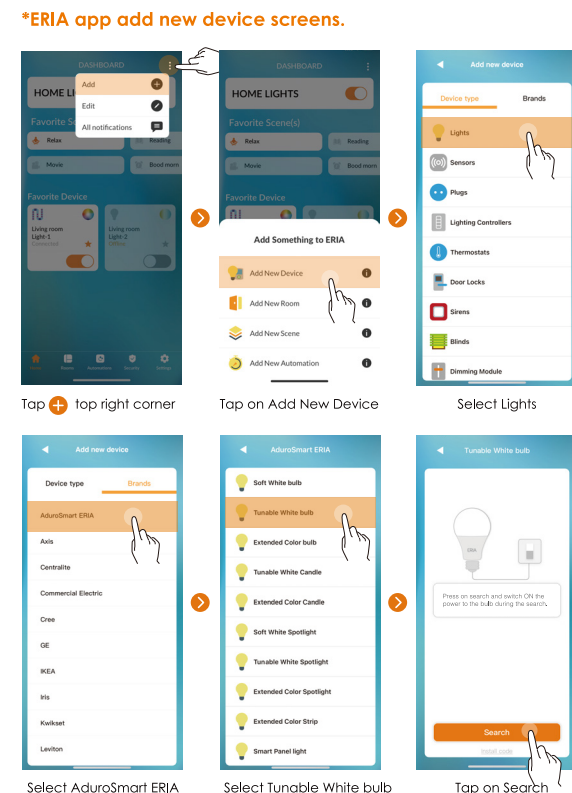

8 While the hub is searching, turn on the downlight. The light will flash once to confirm a successful pairing.

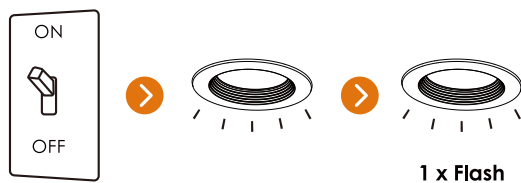

The device will appear in your app and the downlight has been added to your smart home hub follow the instructions in from the app.

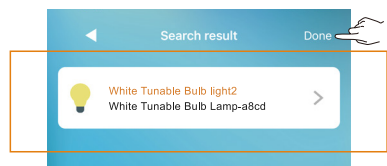

If the downlight does not appear in the app, please follow the reset instructions in Chapter B on the next page to restore the downlight to factory settings. After that, attempt to pair it again using the instructions in steps 6 and 7.

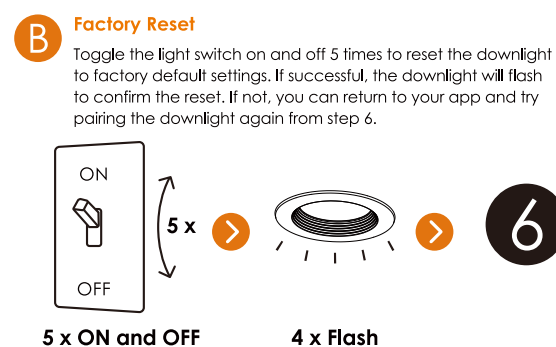

Support

For troubleshooting, instruction video's or more information please visit our website for web support at www.adurosmart.com/faq Chat with one of our support at www.adurosmart.com. Send emails to support@adurosmart.com Support line: 424 363 3420

If you like us! please leave us a review!
And if you need help please reach out to us for further assistance!

Scan the QR code below to access the digital version of our manual and FAQ for additional support.



Regulatory & Legal & Compliance Information

Specifications
To see more ERIA product specifications applicable to this product go to www.adurosmart.com/product-category/eria-products

Certification
ERIA products adhere to the various certification requirements for regions around the world. To see a complete listing of ERIA certifications go to www.adurosmart.com/ compliance to check if this ERIA product complies with the requirements for certification in your area or region.

WARNING - Risk of fire or electric shock. LED Retrofit kit installation requires knowledge of luminaires electrical systems. If not qualified, do not attempt installation. Contact a qualified electrician.

WARNING - Risk of fire or electric shock. Install this kit only in luminaires that have the construction features and dimensions shown in the photographs and/or drawings and where the input rating of the retrofit kit does not exceed the input ratings of the luminaire.

Do not make or alter any open holes in an enclosure of wiring or electrical components during kit installation.

WARNING -To prevent wiring damage or abrasion, do not expose wiring to edges of sheet metal or other sharp objects.

Please examine all parts that are not intended to be replaced by the retrofit kit for damage and replace any damaged parts prior to installation of the retrofit kit.

THIS DEVICE IS NOT INTENDED FOR USE WITH EMERGENCY EXITS or NOT FOR EMERGENCY LIGHTING

SUITABLE FOR TYPE IC OR NON-IC LUMINAIRES

This lamp is only compatible with provided or other specified controls listed in these instructions for proper functionality. This lamp will not operate properly when connected to a standard incandescent dimmer or other off-shelf dimming controls.

The ERIA Recessed Smart Light is designed to install into most recessed fixture can. However, please be aware that it may not be compatible with some models. Always ensure a secure fit into the can and ensure that the ERIA Recessed Smart Light fits firmly against the ceiling and does not sag out of the fixture.

This product is rated for 110-130V use. However, do not install this product directly on branch circuits over 120V in the United States. The US National Electrical Code does not permit connecting Medium lamp holders directly to branch circuits greater than 120 volts "or equivalent."

TWO-YEAR LIMITED WARRANTY

Warrant this product to be free from defects in material and workmanship for two years from the original date of purchase by the consumer. This warranty is limited to the counter replacement at the time of purchase, with the original purchase receipt. will not be liable for the loss or damage of any kind, whether based on warranty contract or negligence, and arising in connection with the sale, use or repair of the product claimed to be defective, some states do not allow the exclusion or limitation of incidental or consequential damages so the above limitation may not apply to you. This warranty gives you specific legal rights and you may also have other rights, which vary from state to state. Misuse, accident, improper installation or maintenance will also void the warranty.

This symbol on the product indicates that this product shall not be treated as household waste. Instead, it shall be sent to the applicable collection point for the recycling of electronic equipment. By ensuring this product is disposed of correctly, you will help prevent potential negative consequences for the environment and human health. For more information about the recycling of this product, please contact your local city office.

DECLARATION OF CONFORMITY
We, the manufacturer / importer, Declare that the product Smart Dimmable LED light: 89843/89863/89846/89868
- "This device is not intended for use with emergency exits or not for emergency lighting"
- "Only use the control provided with or specified by these instructions to control this lamp, this lamp will not operate properly when connected to a standard (incandescent) dimmer or dimming control"

Title 20 CEC
Declaration of conformity we, the manufacturer / importer, Declare that the product Smart Dimmable LED light 89843/89863/89846/89868

FCC

FCC Statement
FCC ID ERIA 4" Smart Recessed Downlight Tunable White & Multi-Color : 2APKV-518946
FCC ID ERIA 5/6" Smart Recessed Downlight Tunable White & Multi-Color : 2APKV-518946
FCC ID ERIA 4" Smart Recessed Downlight Tunable White: 2APKV-518946
FCC ID ERIA 5/6" Smart Recessed Downlight Tunable White: 2APKV-518946

This device complies with part 15 of the FCC Rules. Operation is subject to the following two conditions:
(1) This device may not cause harmful interference, and (2) this device must accept any interference received, including interference that may cause undesired operation.

NOTE: This equipment has been tested and found to comply with the limits for a Class B digital device, pursuant to part 15 of the FCC Rules. These limits are designed to provide reasonable protection against harmful interference in a residential installation. This equipment generates, uses and can radiate radio frequency energy and, if not installed and used in accordance with the instructions, may cause harmful interference to radio communications. However, there is no guarantee that interference will not occur in a particular installation. If this equipment does cause harmful interference to radio or television reception, which can be determined by turning the equipment off and on, the user is encouraged to try to correct the interference by one or more of the following measures:
- Reorient or relocate the receiving antenna.
- Increase the separation between the equipment and receiver.
- Connect the equipment into an outlet on a circuit different from that to which the receiver is connected.
- Consult the dealer or an experienced radio/TV technician for help.
Warning: Changes or modifications not expressly approved by the party responsible for compliance could void the user's authority to operate the equipment.

The distance between user and products should be no less than 20cm.

Contact us
Aduro Technologies LLC
390 Armapola Ave, Suite 4 Torrance, CA 90501
USA
TEL: 424 363 3420
Email: support@adurosmart.com
Website: www.adurosmart.com

Changes & modification
If you modify or change this device you may void the certification of the device. The user's authority to operate this equipment could be void if the changes or modifications you make to this product are not expressly approved by the relevant person(s) responsible for it's compliance.

Environmental specification:
--Temperature (operation): -10~45 C
--Temperature (Storage) : -25~60 C
--Relative humidity: 5-95% non-condensing
--Standby power: 0.5W per lamp
ERIA products are not designed for use in:
-- For safety reasons, do not open the device, doing this will void the warranty.
-- Only use the adaptor supplied; using a different adaptor can damage the device.
-- Only use this bulb in a socket that is rated for this bulb.
-- This device is not designed to be played with by children like a toy.
-- Do not place the device on hot surfaces.

Warnings and cautions:
-- The bulb is suitable for use in open lighting fixtures.
-- The bulb is not suitable for totally enclosed lighting fixtures.
-- The bulb is not intended for use in emergency exit fixtures or emergency lights.
-- The bulb is not suitable for use with dimmers.
-- Before replacing, turn off the power and let the cool to avoid electrical shock or burn.
-- Risk of electric shock.
-- Do not use the device where directly exposed to water.
-- The device is for indoor use only.
-- Do not use the device in wet locations, e.g. bathrooms or outdoors.

While using this product:
-- Switch off the power supply to the socket and allow sufficient time for the bulb to cool before removing the bulb from the fitting
-- Do not clean the device when it is on and connected to the power supply.
-- Remove the waterproofing silicone sleeve from outdoor capable bulbs when using them indoors.
-- Do not open the device, as this will void the warranty.
-- To avoid scratching the device, clean only with a soft dry cloth
-- Do not use cleaning agents to clean the device.
Wireless Specification:
-- Wireless RF mode frequency band: 2400~2483.5Mz
-- Wireless communications protocol: IEEE 802.15.4
-- Operating channels: channels 11-26

Exclusions & Limitations

This Limited Warranty applies only to the product manufactured by or for ADURO Technologies that can be identified by the "ERIA" trademark, trade name, or logo affixed to it "The Limited Warranty does not apply to any (a) ERIA products and services other than the product, (b) non-ADURO Technologies hardware product, (c) consumables (such as batteries), or (d) software, even if packaged or sold with the product or embedded in the product. Refer to the licenses accompanying the software for details of your rights with respect to its use. ADURO Technologies does not warrant that the operation of the product will meet your needs or requirements or be uninterrupted or error-free. ADURO Technologies is not responsible for damage arising from failure to follow instructions relating to the Product's use or from failures resulting from inadequate electrical supply or internet access. This warranty does not apply to a product or part of the product that has been altered or modified (e.g. to alter functionality or capability) by anyone who is not a representative of ADURO Technologies or if the product is inserted or installed in a casing not provided by ADURO Technologies. In addition, this Limited Warranty does not apply to Defects or damage caused by (a) use with non-ADURO Technologies lights, (b) accident, abuse, misuse, flood, fire, earthquake or other external causes or abnormal conditions; (c) operating the product outside the permitted or intended uses or conditions described by ADURO Technologies or with improper voltage or power supply; or (d) service (including upgrades and expansions) performed by anyone who is not a representative of ADURO Technologies. Recovery and reinstatement of software programs and user data are not covered under this Limited Warranty. This Limited Warranty does not cover the cost of returning the product to ADURO Technologies, this is your responsibility. No ADURO Technologies reseller, agent, or employee is authorized to make any modification, extension, or addition to this Limited Warranty. If any term is held to be illegal or unenforceable, the legality or enforceability of the remaining terms shall not be affected or impaired.

Exclusive warranties
The Warranties set forth herein are the exclusive Warranties Provided by ADURO Technologies. And except to the extent prohibited by applicable law, all other warranties, whether express or implied warranties (including warranties of merchantability, fitness for a particular purpose and non-infringement) are hereby excluded.

Limitation of damages
Except to the extent prohibited by applicable law, ADURO Technologies shall not be liable for any incidental, indirect, special, or consequential damages resulting from any use of the product or breach or express or implied warranty or condition, or under any other legal theory. ADURO Technologies liability for damages resulting from any use of the product or breach of express or implied warranty or condition, or under any other legal theory will be limited to the original cost paid for the defective product.